



# 60KW PCS USER MANUAL

## (Installation, Operation & Maintenance)

**Model Name:** 60KW PCS

**Model #'s:** RES-DCVC60KW-480  
RES-DCVC60kW-480-V2G

**Document Number:** 100-PBJ2367-PAM

**Version Date:** – August 29, 2022

The statements in this document must not be changed without special notification from Rhombus Energy Solutions, Inc.

Furthermore, Rhombus Energy Solutions, Inc. does not commit to any further obligations with this document.

Use and reproduction is only permitted in accordance with the contractual agreements.

Under no circumstances may parts of this publication be copied, reproduced, stored in a retrieval system, or translated into another language, except with written permission from Rhombus Energy Solutions Inc.

© Copyright

**Rhombus Energy Solutions, Inc.**

15301 Century Dr., Suite 204

Dearborn, MI 48120

Tel: 1-888-978-6564

## 1. REVISION HISTORY

Version	Description	Date
100-PBJ2367-PAA	DRAFT – In Development	Dec 9 <sup>th</sup> 2019
100-PBJ2367-PAB	2 <sup>nd</sup> Draft	Jan 21 <sup>th</sup> , 2020
100-PBJ2367-PAC	Initial release	Apr 22 <sup>nd</sup> , 2020
100-PBJ2367-PAD	Sec 11: Maintenance, Add DC capacitor measurement point images. Appendix 1D: Add mounting pad template drawing.	Jun 23, 2020
100-PBJ2367-PAE	Revised installation checklist table.	Jun 29 <sup>th</sup> , 2020
100-PBJ2367-PAF	Add Modbus to support AC meter communication.	Aug 25, 2020.
100-PBJ2367-PAG	Added Lockout/Tag out for AC disconnect switch. (pg 24) Added rear conduit connection option. (Pg 30)	Sept 9 <sup>th</sup> , 2020
100-PBJ2367-PAH	Updated tools and wire recommendations	Dec 8 <sup>th</sup> 2020
100-PBJ2367-PAI	Wire sizing guide and recommendations made to be a separate document.	Dec 23 <sup>rd</sup> , 2020
100-PBJ2367-PAJ	Update conduit recommendation and clarification of manual	Sept 1, 2021
100-PBJ2367-PAK	Update the UL Certification Spec	Dec. 17, 2021
100-PBJ2367-PAL	Update Wire & Cable requirements	Feb. 22, 2022
100-PBJ2367-PAM	Update Conduit and Spares list	Aug. 29, 2022

## 2. CONTENTS AND ABBREVIATIONS

1.	REVISION HISTORY .....	1
2.	CONTENTS.....	2
3.	ABBREVIATIONS .....	4
4.	SYMBOLS .....	8
5.	IMPORTANT SAFETY INSTRUCTIONS .....	9
6.	PRODUCT SPECIFICATIONS .....	11
7.	PRE INSTALLATION NOTES.....	12
8.	INSTALLATION CHECKLIST .....	13
	RECOMMENDED TOOLS FOR INSTALLATION .....	14
9.	INSTALLATION.....	14
	UNPACKING THE EQUIPMENT .....	14
	WIRING REQUIREMENTS AND PRE-TESTS .....	14
	SECURE PCS TO MOUNTING PEDESTAL.....	16
	HIGH VOLTAGE CABLE CONNECTIONS .....	17
	LOW VOLTAGE AND COMMUNICATION CONNECTIONS.....	23
10.	PCS OPERATION.....	25
	SAFETY CHECKS / REPAIRING THE PCS FOR OPERATION .....	25
	PCS STATUS LED .....	26
	EMERGENCY STOP .....	26
11.	MAINTENANCE .....	27
	SAFETY PRECAUTIONS FOR EQUIPMENT MAINTENANCE .....	27
	HIGH VOLTAGE ELECTRICAL EQUIPMENT MAINTENANCE .....	28
	HIGH POWER CABLE CONNECTIONS .....	28
	AIR INTAKE AND FILTERS .....	28
	ENCLOSURE INLET AND EXHAUST VENTS .....	28
	SPARE PARTS LIST .....	30
12.	APPENDIX .....	32
	APPENDIX 1A: DETAILED SCHEMATIC RES-DCVC60KW-480 .....	32
	APPENDIX 1B: DIMENSIONS (RES-DCVC60kW-480) .....	33
	APPENDIX 1C: INSTALLATION CLEARANCE REQUIREMENTS (RES-DCVC60kW-480) .....	34
	APPENDIX 1D: ANCHOR AND CONDUIT INSTALLATION TEMPLATE (RES-DCVC60kW-480) .....	35

<b>Abbreviation</b>	<b>Definition</b>
ANSI	American National Standards Institute
AWG	American Wire Gauge
CIU	Customer Interface Board
CCSM	Combined Charging System Module
EPO	Emergency Power Off
GFDI	Ground Fault Detector Interrupter
HV	High Voltage
IDLE MODE	RES Converter is waiting for ON Command
IEEE	Institute of Electrical and Electronics Engineers, Inc.
IGBT	Insulated Gate Bipolar Transistor
ISO	International Organization for Standardization
ITB	Interface Terminal Board
kVA	Kilovolt Amperes
kW	Kilowatt
LOTO	Lock Out Tag Out
LV	Low Voltage
LVPS	Low Voltage Power Supply
MCB	Miniature Circuit Breaker
MIC	Main Converter Controller (Control Board)
MIU	Main Control Board
MSDS	Material Safety Data Sheet
NEC	National Electric Code
NFPA	National Fire Protection Association
OEM	Original Equipment Manufacturer
PCS	Power Control System
PV	Photo-Voltaic
RES	Rhombus Energy Solutions
VAC	Voltage, Alternating Current
VDC	Voltage, Direct Current
VS	Voltage Sense (Circuit Board)

### 3. QUICK START GUIDE

**FOR REFERENCE ONLY. READ THE ENTIRE MANUAL BEFORE INSTALLATION**

#### **CRITICAL ITEMS**

1. **STEEL CONDUIT** for the Communication lines running between the PCS and Dispenser is recommended to protect the Communication Links between machines. PVC can be used as long as you maintain a minimum of 18" between HVDC and Communication Conduit along the run between the PCS and Dispenser
2. **PVC Conduit** may be used for the AC Feed to the PCS and High Voltage DC Lines as long as there is a minimum of 18" between the communication and HVDC conduits.
3. CAN (Green/Yellow and Shield) and ModBus (Orange/Blue and Shield) Wires must be Shielded Twisted Pairs as specified in the ***LOW VOLTAGE AND COMMUNICATION*** section of this manual.
4. You must use the recommended color-coded wire types specified in the ***LOW VOLTAGE AND COMMUNICATION*** section of this manual.
5. All Low Voltage Wires should be verified and marked/tagged to ensure proper installation in the correct position.
6. All LV wire ends are to be Ferruled (ferrules included with PCS)
7. High Voltage AC and DC Cables are to be Lugged with the appropriate Lug for the Cable Size and Connection.
8. **DO NOT CONNECT THE BATTERY** until advised to do so by Rhombus Service. Ensure the disconnected battery leads are insulated and not touching any metal objects.

## BEFORE YOU POWER UP THE MACHINE

1. Ensure all HV AC and DC connections are installed properly and torqued to the recommended value in both the PCS and Dispenser.
2. In the Dispenser, verify the LV Wires are properly installed in the correct positions in the Terminal Block. Using the supplied Wire Labels, label each wire before connecting them to the terminal block.

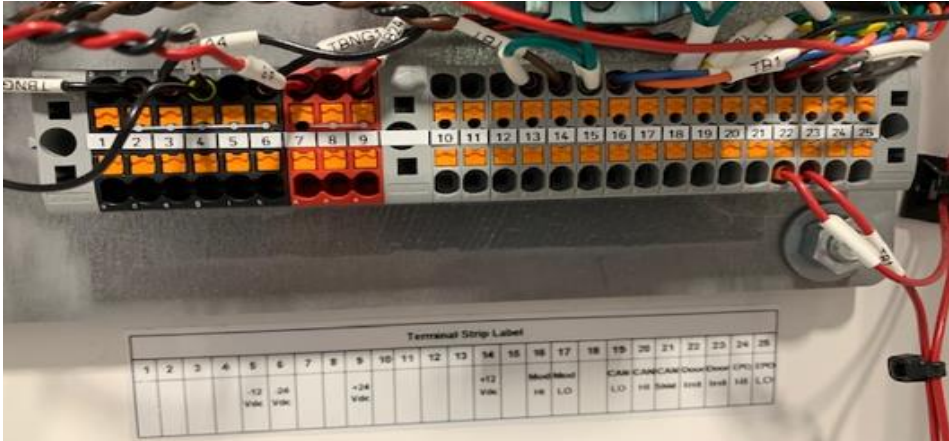

3. In the Dispenser, check the Antenna connections from the Dispenser lid to the Cradlepoint (if installed).  
(Do not use this connection) (Yellow Cables on TOP) (Orange Cables on BOTTOM)



4. In the Dispenser, check LED Light Connections for proper orientation

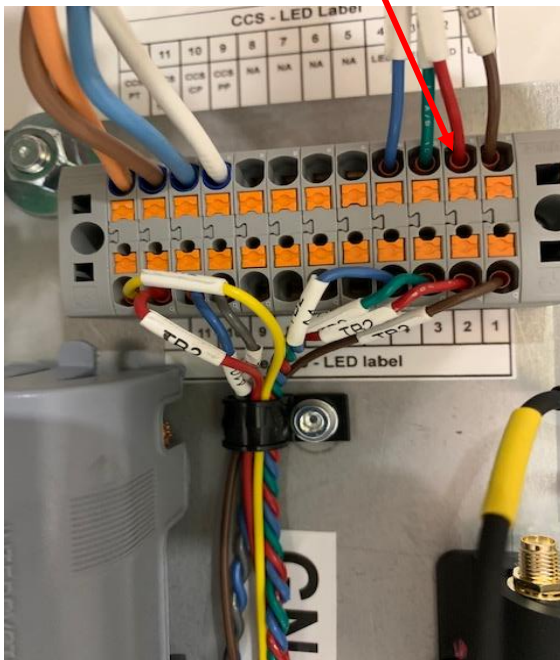

5. In the PCS, verify wire orientation in the Customer Connection Terminal Block. Using the supplied Wire Labels, label each wire before connecting them to the terminal block.



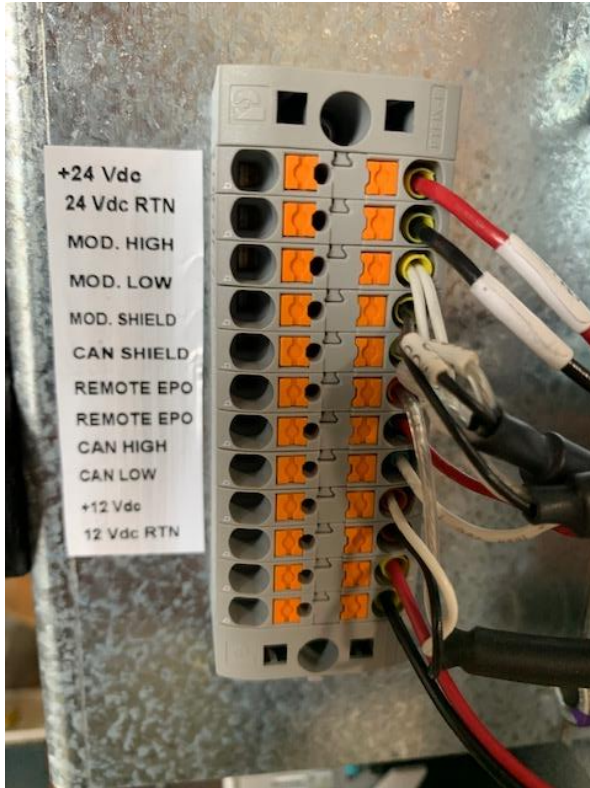

- 1 +24Vdc (POS)
- 2 24Vdc Return (NEG)
- 3 Modbus High
- 4 Modbus Low
- 5 Modbus Shield
- 6 CAN Shield
- 7 Remote EPO Out (Red)
- 8 Remote EPO In (White)
- 9 CAN High (Green)
- 10 CAN Low (Yellow)
- 11 +12Vdc (POS)
- 12 12Vdc Return (NEG)



6. In the PCS, reference the **HIGH VOLTAGE CABLE CONNECTIONS** section of this manual for proper installation of the AC Input, DC Output, Grounds and Verivolt Isoblock Connections.
7. **DO NOT** apply power to the PCS before Completing the Commissioning Checklist and taking pictures of the Customer Connection Blocks. **These must be approved by Rhombus Service prior to applying power to the PCS.**
8. **APPLYING POWER TO THE PCS PRIOR TO RHOMBUS APPROVAL MAY DAMAGE THE EQUIPMENT AND VOID THE WARRANTY.**

#### 4. SYMBOLS



	Danger of electric shock hazard
	Warning: Failure to follow procedures may result in injury or death to the operator
	Caution: Failure to follow procedures may result in damage to the RES Converter.
	Ground connection to the building (or site) ground
	Chassis connected to ground

**Disclaimer**

There may be variance in the exact procedures used to install/operate the RES Equipment. This manual cannot possibly anticipate all such variations nor provide advice or cautions to all. Before deviating from the instructions in this manual, the installer/operator must first establish that neither personal safety, nor the integrity of the RES Equipment is compromised.

Because of the wide variety of uses for power electronics equipment, this manual does not describe every possible application or configuration. All personnel responsible for installing, commissioning, and operating this equipment must have personal assurance of the suitability and proper implementation, installation and of the intended application of this power product. In no event will Rhombus energy systems, Inc., its subsidiaries, employees, or affiliates be responsible or liable for any damages, indirect or direct, resulting from the misuse or incorrect application of this equipment.

The examples and diagrams in this manual are for illustrative purposes only. Because of the wide variety of uses, applications, peripheral equipment, and facility configurations to each installation, Rhombus Energy Solutions cannot assume responsibility or liability for actual use based on the information provided here.

## 5. IMPORTANT SAFETY INSTRUCTIONS

### SAVE THESE INSTRUCTIONS

# THIS MANUAL CONTAINS IMPORTANT INSTRUCTION ON RHOMBUS POWER CONVERSION SYSTEM (PCS) EQUIPMENT THAT SHALL BE FOLLOWED DURING INSTALLATION AND MAINTENANCE.



**WARNING:** These are important safety instructions. Save these instructions. Failure to follow the cautions and warnings may result in damage to the equipment, personal injury, or death.

This manual contains WARNINGS and CAUTIONS. Warnings indicate actions that may result in an accident, which could cause bodily injury or death. Cautions indicate procedures that could result in damage to the PCS Equipment. Observe all WARNINGS and CAUTIONS. Failure to do so may result in personal injury or damage to the PCS Equipment.

● ***Please read entire installation manual and associated safety procedures/warnings prior to installing equipment.***



● Store provided enclosure key in a secure location.

#### General Safety

- Equipment to be installed and serviced by authorized personnel only.
- Over-current protection (hardware) for the AC output circuit is to be provided by the installer.
- Make sure that all grid or vehicle (Inputs/Outputs) have been disconnected from the PCS and Dispenser before servicing unit. (Unless specifically required by the procedure with appropriate safety precautions.
- Wear proper level PPE Personal Protective Equipment &/or clothing (gloves, apron, etc.) approved for working on high voltage equipment.
- Keep all guards, screens, and electrical enclosures in place when the system is operating.
- FOLLOW ALL INDUSTRY-RECOMMENDED SAFETY PROCEDURES AND STANDARDS WHEN SERVICING THE PCS



Equipment is a possible tip hazard. Do not move equipment without appropriate mechanical assistance. (Eg: Forklift with appropriate capacity rating)

	<p><b>DANGER:</b> This Power Converter System generates high voltage. Pay close attention to ALL warnings, cautions, and safety instructions. Failure to do so may result in electrical shock leading to personal injury or death.</p>
	<p><b>WARNING:</b> To reduce the risk of fire, connect only to an AC Line Circuit provided with appropriate maximum branch-circuit overcurrent protection in accordance with the National Electrical Code, ANSI/NFPA 70.</p> <p><b>Electrical Connections:</b> Be sure that all electrical connections and connectors are properly installed and connected with appropriate torque.</p> <p><b>Improper Use:</b> Rhombus Energy Solutions cannot assume responsibility for personal injury and/or equipment damage because of improper installation, use, maintenance, reconfiguration, reprogramming, or other improper actions.</p> <p>An incorrectly serviced or operated PCS system can cause personal injury, component damage, or reduced product life.</p> <p>Malfunction may result from wiring errors, an incorrect or inadequate DC supply or AC grid connection, excessive ambient temperatures or obstructed ventilation, or incorrect software configuration.</p>
	<p>Keep the door closed always when operating the system. Additionally, keep all guards, screens, and electrical enclosures in place when the system is operating. Close the inverter enclosure and put all guards and screens in place before energizing the PCS</p> <p><b>Locked Doors:</b> The PCS enclosure should remain locked always during normal operation and should only be unlocked for maintenance by qualified personnel.</p> <p>Enclosure keys should be stored in a safe place and should be accessible to appropriate personnel only</p> <p>Install PCS only after reading and understanding the complete instructions as specified in the manual.</p> <p>Improper Installation can result in severe personal injury or death, and equipment damage. The installer must be qualified to perform the installation of electrical and mechanical equipment.</p> <p>Ensure that the mounting method and all connections comply with local codes and ordinances</p> <p>Observe all local and national safety regulations.</p> <p>Observe local regulations regarding wiring different circuits in the same conduit. In general, all conductors occupying the same conduit must have an insulation rating equal to at least the maximum circuit voltage applied to any conductor within the conduit.</p> <p>The 60kw charger must be connected to a circuit provided with appropriate branch circuit over-current protection in accordance with the National Electrical Code, ANSI/NFPA 70</p>

## 6. PRODUCT SPECIFICATIONS

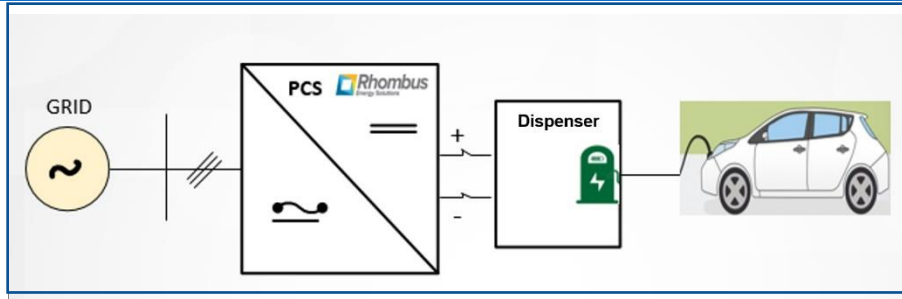

The 60kW Rhombus Power Conversion System PCS converts between three phase AC grid voltage to high voltage DC. The high voltage DC is then transferred to an electric vehicle through an electric vehicle charging dispenser or remote charging unit (RCU) and cable.

### ELECTRICAL (High Voltage AC Grid)

Utility Grid Voltage (Vac)	480 +10%/-20% {384* – 528} Vac (3 phase)
Utility Grid Frequency (Hz)	60Hz ±3%
Max Rated Utility Grid Current	79A @480Vac (60Hz)
Standard Wiring	4- Wire 3 phase (L <sub>1</sub> , L <sub>2</sub> , L <sub>3</sub> , Ground)

\*Note: Power de-rate begins when AC voltage falls below 456VAC

### ELECTRICAL (High Voltage DC)

Nominal Output Power	60 kW Max
Output Voltage (Vdc)	270 – 870 Vdc
Output Current (Adc)	200A (Max)

### SAFETY AND OPERATIONAL RATING

Enclosure Rating	NEMA 3R
Safety Standards	UL standards 2202, 2231, 1741SA
Surge Protection	6kV @ 3000A. In geographic areas subject to frequent thunderstorms, supplemental surge protection at the service panel is recommended.
EMC Standards	IEEE1547
Efficiency	>94%
Power Factor	0.97 @ 60KW
Cooling	Forced Air Cooled
Operational Temperature	-20 °C to 45 °C (-4°F to 113°F) Output power derating may apply above 45°C (113°F)
Storage Temperature	-30 °C to 60 °C (-22°F to 140°F)
Operating Humidity	0 to 95% (Non – Condensing)

### GENERIC SPECIFICATIONS, PCS

Dimensions (Enclosure with Base Plinth)	31.5W x 24.5D x 82H inches
Shipping Dimensions	40.00W x 37.0D x 84.00H inches
Weight	~1650 Lbs.
Shipping Weight	~1850 Lbs.

**NOTE:** Rhombus reserves the right to alter product offerings and specifications at any time without notice and is not responsible for typographical errors that may appear in this document.

## 7. PRE INSTALLATION NOTES



### IMPORTANT SAFETY INSTRUCTIONS

- Ensure that the appropriate wiring, circuit protection, and metering are in place at the installation location by reviewing the specifications, wiring diagrams, and grounding requirements described in this Installation manual.
- Confirm that the installation site location evaluates the following needs:
  - Appropriate floor/ground load capacity and footprint area.
  - Equipment access for installation and/or removal.
  - Site Selection to consider adequate space for equipment service and maintenance.

**Consider space required for door swing or panel removal clearance and access. For dimensions and clearances refer to Appendix 1C**

**Adequate space for air to circulate through the equipment and or enclosure consistent with local, state, and national electrical installation guidelines. Do not block the intake or exhaust ports.**

- The PCS and dispenser must be connected to appropriately sized earth ground.

**ALL LV COMMUNICATION WIRES MUST BE IN SEPARATE CONDUIT THAN THE HIGH VOLT DC AND DC SENSE WIRES**

- **Please see separate “Rhombus DC Fast Charger Wire Requirements Guide” for details about wire types, sizing and supplier suggestions.**
- **Evaluate compliance w/ local rules and regulations before finalizing wire/cable selections.**

The dispenser offers hardwired ethernet connectivity as “standard” and Wi-Fi &/or cellular connectivity as a recommended option. Please determine the dispenser options and configurations along with the customers connectivity preference when evaluating the hard wired ethernet infrastructure. See Appendix for additional information on network connectivity.

## 8. INSTALLATION CHECKLIST

**Note: Completed checklist required for product warranty and support eligibility.** Please read manual prior to installation for important safety and installation details. Complete, sign and submit this checklist & supporting information to your Rhombus sales or service representative. (Sample image below. Digital (preferred) &/or full size print out available separately)

<b>Equipment Installation and Approval Checklist (V1.2)</b>			
Site Address: _____			
PCS Model #: _____	Serial #: _____		
Dispenser Model #: _____	Serial #: _____		
Dispenser/RCU PCBA Serial #(s): _____			
Inst. by (Co. Name): _____	Employee Name: _____ Lic. #: _____		
Comm. By (Co. Name): _____	Employee Name: _____		
Comm. Signature: _____	Date: _____		
#	X	Item	Description
1		All	Read the product installation manual. Verify AC feed to PCS has been LOTO
2			PCS bolted/secured to mounting pad to prevent tipping.
3			Verify wire gauges, shielding and insulation ratings comply w/ PCS requirements and applicable local &/or national safety regulations.
4			Verify all high voltage DC (power and sense) wire insulation resistance using an insulation tester prior connecting to PCS or Dispenser to check for possible wire or cable damage. E.g.: Fluke 1520 1kV Insulation Tester/Megaohm meter or similar. Tests: <b>High voltage DC power cables:</b> <input type="checkbox"/> HV+ to HV+ _____ mΩ (Must be greater than 0.5MΩ to Pass) <input type="checkbox"/> HV+ to GND _____ mΩ (Must be greater than 0.5MΩ to pass) <input type="checkbox"/> HV+ to Gnd _____ mΩ (Must be greater than 0.5MΩ to pass) <b>High voltage DC sense wires:</b> <input type="checkbox"/> HV+ to HV+ _____ mΩ (Must be greater than 0.5MΩ to pass) <input type="checkbox"/> HV+ to GND _____ mΩ (Must be greater than 0.5MΩ to pass) <input type="checkbox"/> HV- to Gnd _____ mΩ (Must be greater than 0.5MΩ to pass)
5			Connect PCS ground terminal to earth ground.
6			Single Line Diagram (Image or PDF)
7			Picture of site/supply transformer plate rating referenced in single line diagram.
8			F 1000V 400/460V AC 1 Line Circuit provided with appropriate maximum branch circuit overcurrent protection in accordance with the National Electrical Code, ANSI/NFPA 70 Circuit Breaker Values: L1 (A): _____ amps, L2 (B): _____ amps, L3 (C): _____ amps
9			Connect E1 (A), L2 (B), L3 (C), N, Gnd) AC Grid connections to the PCS.
10			Verify 3P AC phase ID and disk/rotary rotation w/ meter. (Fluke 3000 Phase Rotation Indicator or similar)
11			Connect high voltage DC (power cables (DC+, DC-) from PCS to the Dispenser.
12			Connect high voltage DC voltage sense wires from dispenser (DC+,DC-) terminal block to PCS's HV sensor ("Verivolt hublock").
13			Connect shielded / twisted pair CAN communication wires from PCS to the Dispenser. Wire shields must be terminated to chassis ground at PCS only.
14			Connect shielded / twisted pair 24Vdc and 12Vdc signal wires from PCS to Dispenser. (Wire shield terminated to chassis ground at PCS only)
15			Connect shielded / twisted pair Remote Emergency Power Off (EPO) from Dispenser to PCS. (Wire shield terminated to chassis ground at PCS only)
16			Complete dispenser installation and wiring.
17			Picture(s) of PCS high voltage AC and DC wiring terminations.
18			Picture(s) of dispenser/RCU high voltage DC wiring terminations.
19			Picture(s) of RCU dispenser circuit board (Need to read serial # and barcode)
20			Picture(s) of PCS Installation: Front, Left side, Right side
21			Picture(s) of Dispenser Installation: Front, Left, Right side
22			Picture(s) of Electrical supply panel.
23			Close PCS and Dispenser
24			Ensure the (Emergency Power Off) EPO red buttons on PCS and Dispenser are not activated. a. PCS: To un-press, rotate EPD counter clockwise and pull. b. Dispenser: Rotate switch to "ON" position.
25			Remove Lock Out Tag Out (LOTO) then switch on the facility's AC circuit panel feed to PCS at breaker panel and/or dedicated equipment switch.
26			Switch the AC Disconnect on the front door of PCS to the ON position.
27			Test operation by verifying successfully plugging in and charging a sample vehicle. (Record maximum power and energy (end of each charge) for each test below as displayed on either dispenser or vehicle dash.)
28			Test 1: Plug in, charge for 5 mins, unplug. Max kW: _____ kWh: _____
29			Test 2: Wait 30 seconds, Plug in, Charge for 5 mins, Unplug. Max kW: _____ kWh: _____
30			Test 3: Wait 30 seconds, Plug in, Charge for 5 mins, Unplug. Max kW: _____ kWh: _____
31			Test 4: Wait 30 seconds, Plug in, Charge for 5 mins, Unplug. Max kW: _____ kWh: _____
32			Test 5: Wait 30 seconds, Plug in, Charge for 30 mins, Unplug. Max kW: _____ kWh: _____

<b>Warranty and Maintenance Terms and Conditions Acceptance</b>	
Company Name	_____
<b>Contact Information</b>	
Commercial	Name: _____
	Address: _____
	Phone #: _____
Technical / Maintenance	E-mail: _____
	Name: _____
	Address: _____
Technical / Maintenance	Phone #: _____
	E-mail: _____
	<b>Site and Product Information</b>
Site Address: (filled in by Rhombus) _____	
PCS Model #: (filled in by Rhombus) _____	Serial #: _____
Dispenser Model #: (filled in by Rhombus) _____	Serial #: _____
<b>Customer has received, read and agreed to Rhombus Terms and Conditions as they relate to product warranty, liability and associated preventative maintenance as defined in Exhibit A (Attached)</b>	
Authorized Customer Representative	
By: _____	
Name: _____	
Title: _____	
Date: _____	
Completed form to be provided to your Rhombus sales representative. Customer will be notified of warranty activation upon receipt of signed form.	

## RECOMMENDED TOOLS FOR INSTALLATION

Items typically needed for PCS installation

- Forklift
- Lifting strap for dispenser (Min: 200lb rating)
- 1000V Rated Multimeter
- Fluke 1520 1kV Insulation Tester/Megaohm meter or equivalent.
- Fluke 9040 Phase Rotation Indicator or equivalent.
- #2 Phillip Head Screwdriver
- Metric standard and deep sockets + open-ended wrenches up to 17mm.
- Metric HEX keys.
- Impact Drill and T-25 Torx Bit

## 9. INSTALLATION

### UNPACKING THE EQUIPMENT

- Upon receiving the PCS Equipment, inspect for signs of damage that may have been caused during shipping. If damage is found, contact Rhombus Energy Solutions at 1-888-978-6564.
- Use forklift with appropriate capacity rating to safely move equipment.



**IMPORTANT:** Always transport and store the Rhombus Power Converters in its original packaging and upright orientation.

### WIRING REQUIREMENTS AND PRE-TESTS

Before connecting the wiring, note the following requirements:

1. Follow safety and building codes when installing the PCS Equipment.
2. External wiring (when required), shall follow the National Electric Code, ANSI/NFPA 70.
3. Any external wiring is the responsibility of the installer.
4. All communication and electrical wiring should be protected in steel conduit.
5. The circuit breaker at the panel must be OFF. Comply with lockout/tagout safety procedures if applicable.
6. Electrical input must be 480V three phase in a Wye configuration.
7. Use 90°C or higher rated copper wire only.
8. The grounding conductor is to be grounded to earth at the service equipment, or when supplied by a separately derived system, at the supply transformer.
9. Installer must have an insulated grounding conductor as part of the branch circuit that supplies the PCS.
10. All connections must comply with all local codes and ordinances.
11. Verify 3P AC phase ID and clockwise rotation w/ meter. (Fluke 9040 Phase Rotation Indicator or similar)
  - a. Label (L1 (A), L2 (B), L3 (C), Neutral (N) & Ground (GND))

12. PRIOR to terminating & connecting high voltage DC power, verify all high voltage DC (power and sense) wire insulation resistance using an insulation tester to check for possible wire or cable damage. (Eg: Fluke 1507 1kV Insulation Tester/Megaohm meter or similar.)

Tests:

- a. (DC+) to (DC-) power cables
- b. (DC+) power cable to chassis ground
- c. (DC-) power cable to chassis ground
- d. (DC+) to (DC-) Remote Sense Wires
- e. (DC+) Remote Sense Wire to chassis ground
- f. (DC-) Remote Sense Wire to chassis ground



## SECURE PCS TO MOUNTING PEDESTAL

Recommend 1/2" or larger corrosion resistant studs or wedge anchors pad to secure PCS to the concrete mounting pad with appropriate washer. McMaster example.

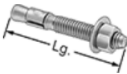
- 1  Galvanized Steel Square Washer  
for 1/2" Screw Size, 0.562" ID, 2" Wide  
91133A120
- 2  Galvanized Steel Stud Anchors for Concrete  
1/2" Diameter, 5-1/2" Long  
97110A302

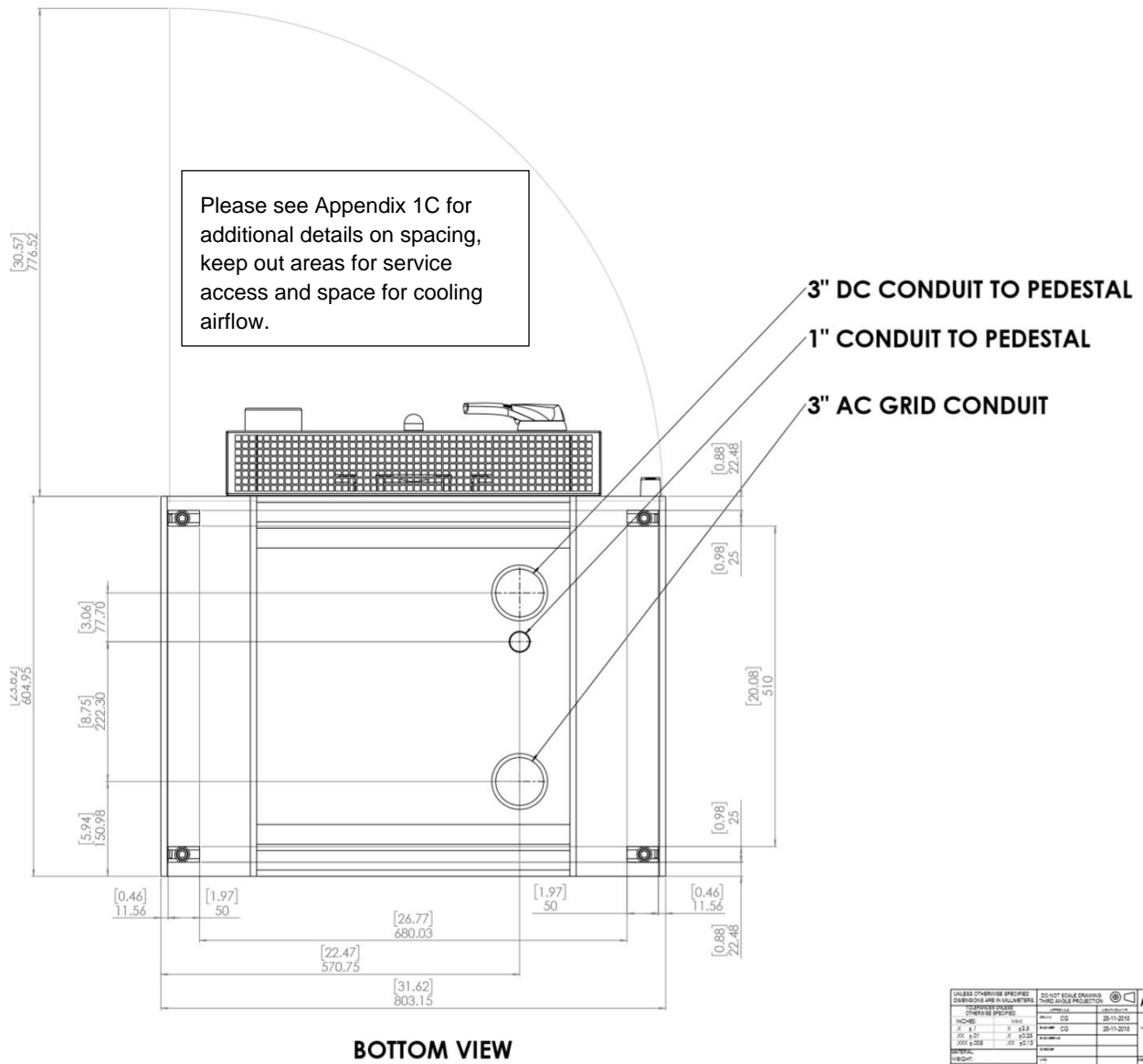

## HIGH VOLTAGE CABLE CONNECTIONS



**WARNING:** Determining the PCS electrical requirements and installing the appropriate wiring must be performed by a qualified electrician.

Ensure the power is off before connecting the wiring.

**Note:** *The PCS includes capacitors that retain energy after the PCS is powered off. Wait at least 5 minutes with the power off before opening the PCS door.*

See Section 11: Maintenance for additional safety precautions after units has been powered up.

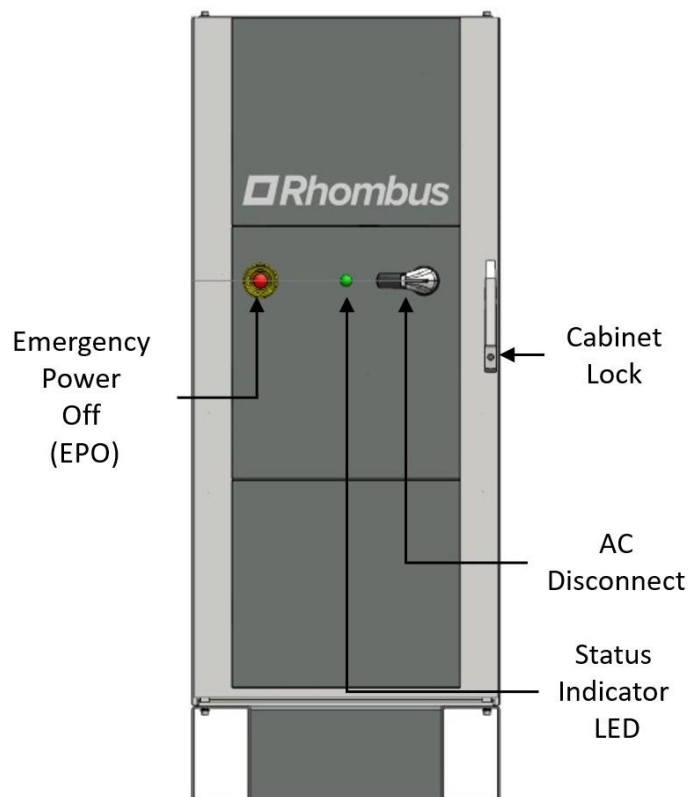

### **STEP: 1** Open the PCS

- Turn the AC disconnect handle to the “OFF” position.
- Unlock and open the PCS cabinet lock.
  - *Note: The key for the PCS is included with each PCS shipment. Replacement key part # and supplier identified in the Spare Parts section.*

**STEP: 2** Locate high voltage, low voltage, ground and communication connections and termination point.

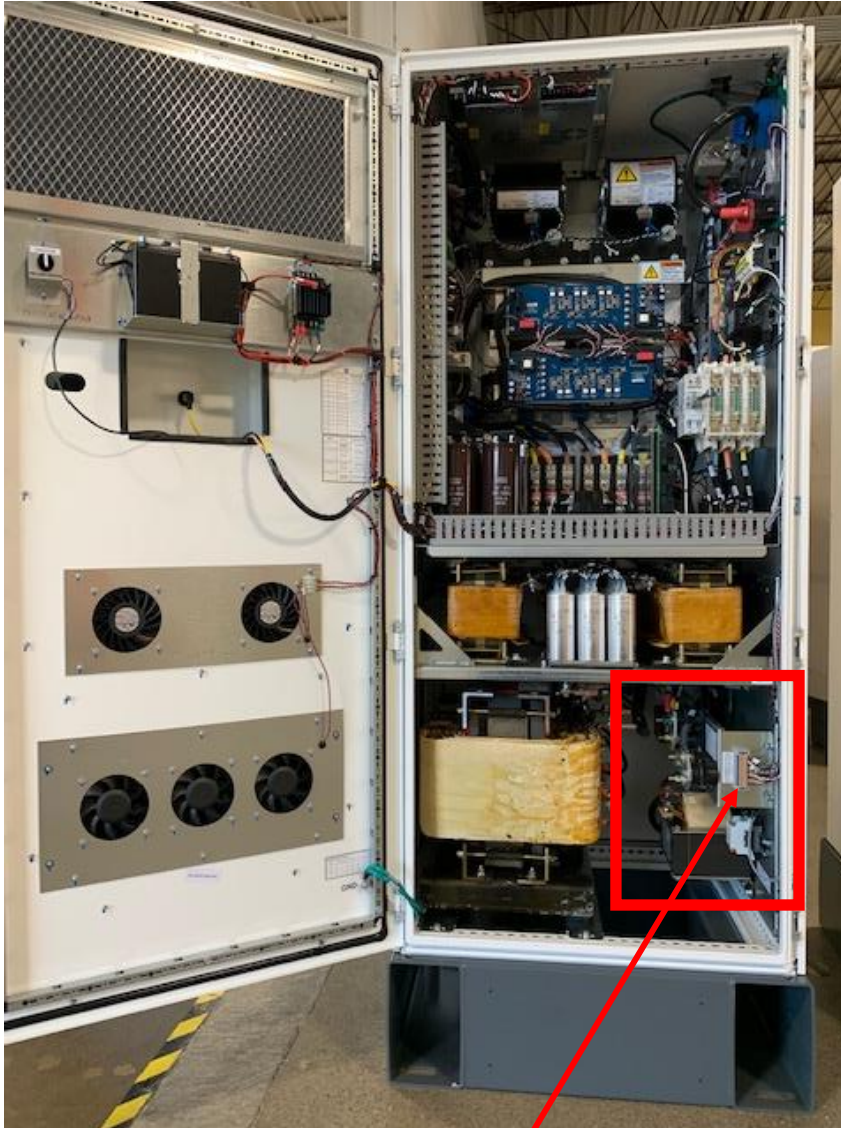

PCS OPEN DOOR FRONT VIEW

- Grid, High Power DC, Low Voltage & communication connections are located in the lower shelf, right side panel of the PCS.

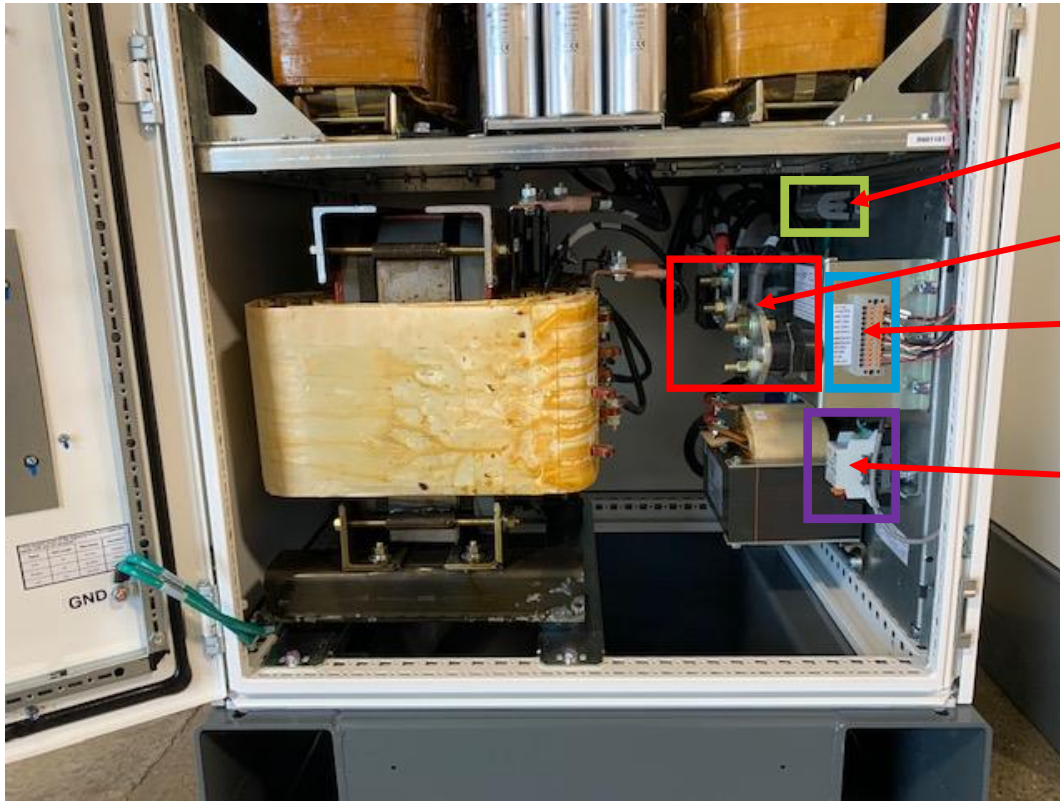

GRID & DC CONNECTIONS LOCATED VIEW

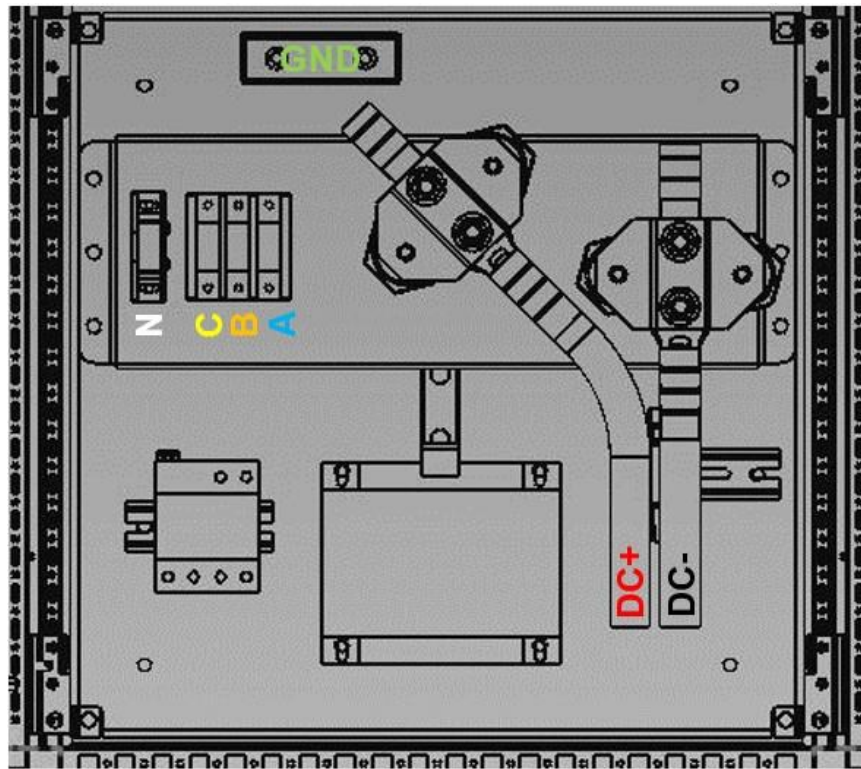

RIGHT-SIDE PANEL VIEW (DC+, DC-, GND)

**STEP:3** Connect the Grid Phase A, B, C and N as specified below (RHS View)

Connections Overview: Cable entry for the Grid is shown below in the Plan View

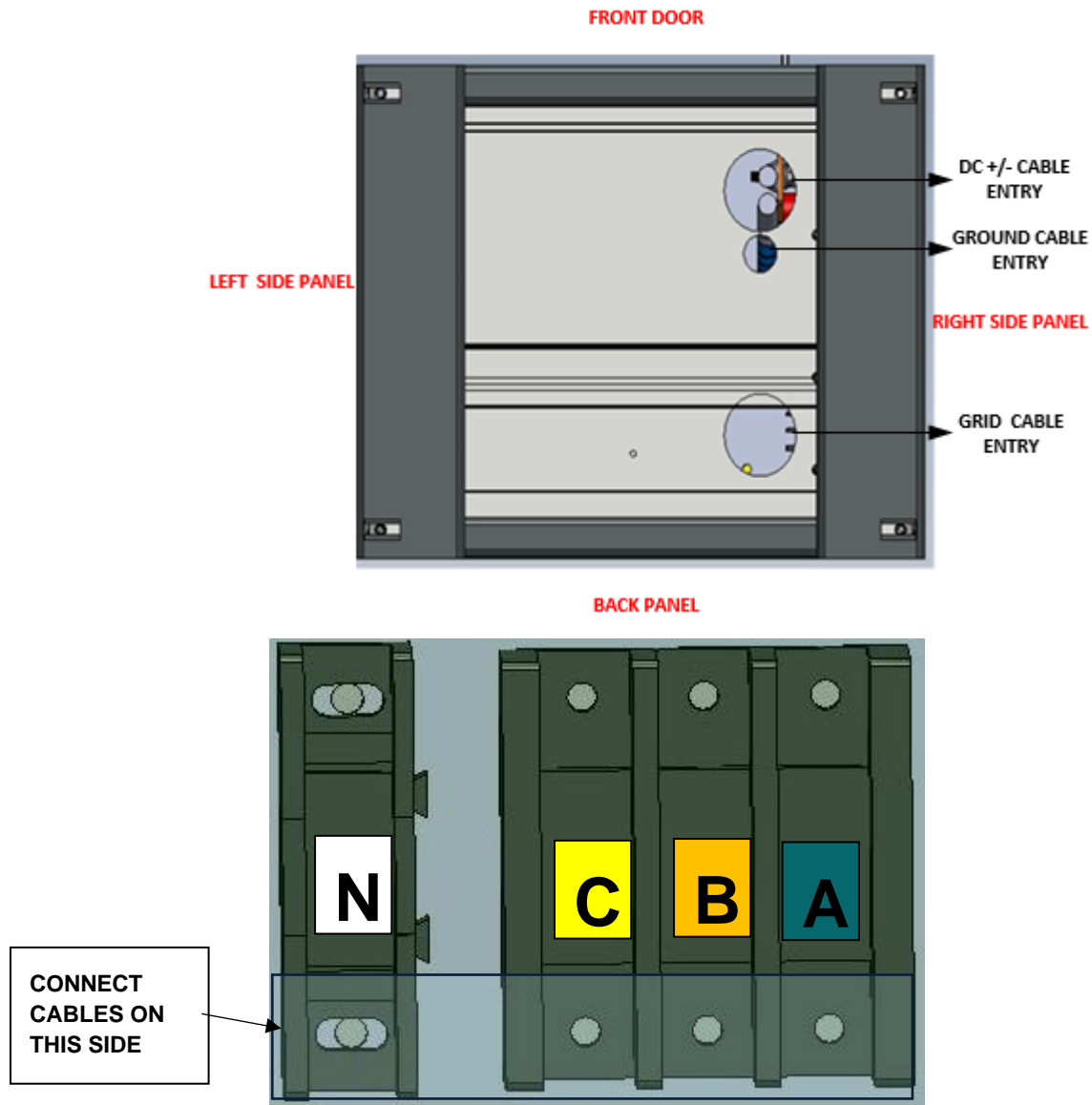

**EXPANDED VIEW OF GRID CONNECTIONS**

- When installing the PCS Equipment, be sure that the phase sequence is correct. The system is phase rotation sensitive. Verify required clockwise phase rotation (A, B, C) with the use of a phase rotation meter. (*Fluke 9040 Phase Rotation Indicator or similar*)
- For wiring the grid you will need 3/16" hex key to loosen the set screw.
- Insert the cable in the opening of the terminal block and tighten set screw to the torque specified in the torque table.

**STEP:4** Connect the ground to the Terminal Grounding bar located on the top of the grid connections



The PCS is shipped with a cover on the Terminal grounding bar.

- Remove the Terminal grounding bar covering.
- Take the No. #2 Philips screwdriver to loosen the screw
- Insert the ground cable (refer to torque table for cable size) in the screw opening.
- Tighten the Screw as per the torque specifications.

**STEP: 5** Connecting the DC connections to the PCS terminal blocks

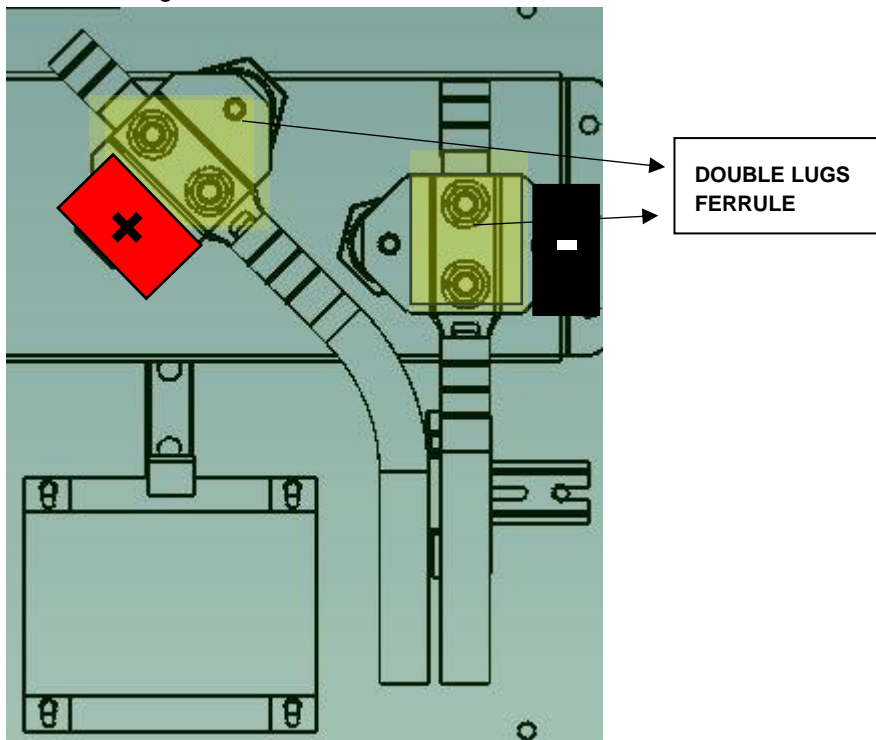

#### DC POSITIVE AND NEGATIVE TERMINALS

- You will need a  $\frac{3}{4}$ " wrench and deep socket to remove the terminal block nuts.
- After removing the nuts, remove the lock washer and flat washer.
- Crimp the lug terminal on the cable. (Dual hole cable lug recommended)

- Assemble the lug to the terminal block using the terminal bolts, flat washers and lock washers. (Make sure there is NO WASHER placed between the cable lug and the terminal block).
- Tighten and torque the bolt as specified in the WIRE SIZE & TERMINAL TORQUE TABLE.

**STEP: 6** Connecting the High Voltage Sense connections to the PCS

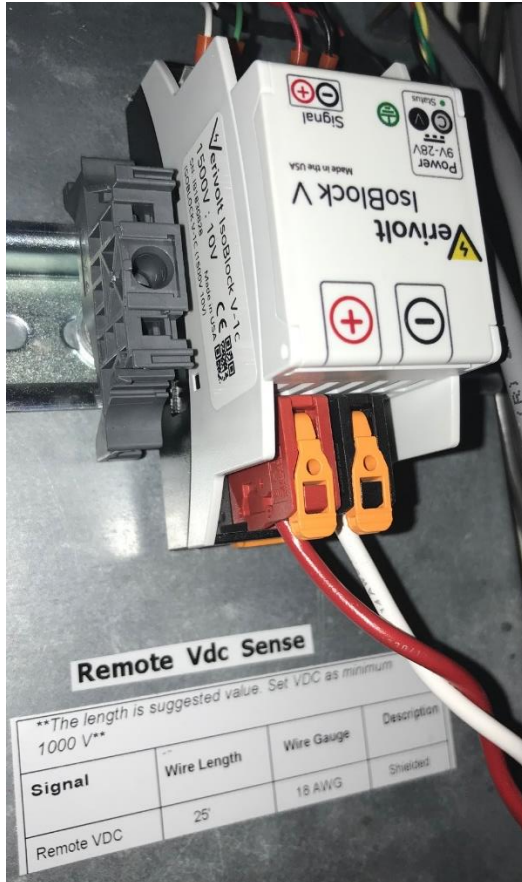

- Insert high voltage, shielded, sense wires into Verivolt IsoBlock

**NOTE:**

- All LV Connections in the PCS and Dispenser must be terminated with a Ferrule prior to installing in Terminal Block (Ferrules supplied with machine).

## LOW VOLTAGE AND COMMUNICATION CONNECTIONS

### WIRE GUIDE QUICK REFERENCE

The following are recommended Wire Sizes, based on 35°C Ambient temperatures, and cable in conduit.  
Follow NEC standards and use only copper conductors.

Cable Description	Minimum Size (In Conduit)	Maximum Size (In Conduit)	# of Conductors	Notes
<b>Grid to 60kW PCS - AC Connections</b>				
(RES-DCVC60-480, AC Grid (Steel or PVC conduit, typically ~3"))				
480 VAC Grid	2 AWG	1 AWG	3	Brown, Orange, Yellow
Neutral	4 AWG	4 AWG	1	White/Grey
Ground/Earth	4 AWG	4 AWG	1	Green
<b>60kW PCS to Dispenser - High Voltage DC Connections</b>				
DC Power (Steel or PVC conduit, typically ~3" Dia)				
High Voltage DC Power	3/0 (up to 400ft) 4/0 (500ft <sup>2</sup> )	373 MCM	2	1000V, 200A + Red/ - Black
High Voltage Sense +/-	18ga	16ga	2	1000V, + Red/ - Black
Ground/Earth	4 AWG	4 AWG	1	Green
<b>60kW PCS to Dispenser - Low Voltage Communication Connections</b>				
Low Voltage / Communication (Steel conduit, typically ~ 1.25")				
15VDC (+/-)	18 ga.	10ga	2	5A
24VDC (+/-)	20 ga.	12ga	2	1A
CAN (H,L)	20ga.	12ga	2 + Shield	Shielded, Twisted Pair
EPO (In/Out)	20ga.	12ga	2	1A
Modbus (Rx/Tx)	20ga.	12ga	2 + Shield	Shielded, Twisted Pair



## PCS Low Voltage Wiring Interface

### How To: Shielded Cable Termination

**Ground termination PCS side only.**

Sample fabrication process.

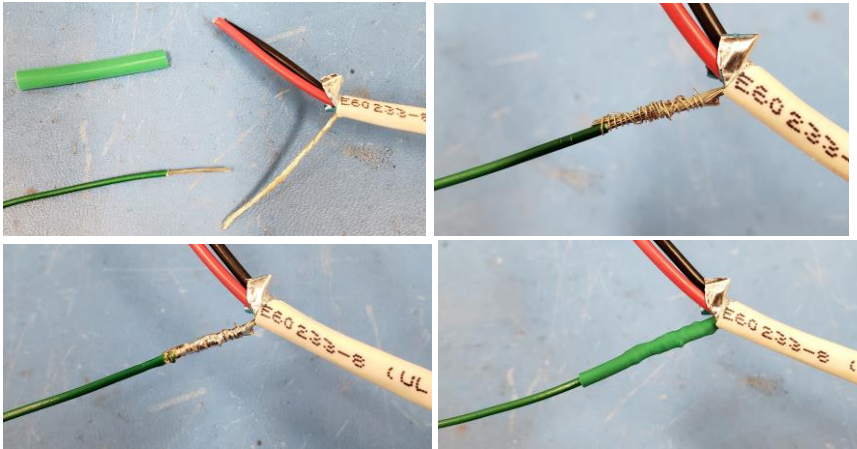

### PCS Low Voltage Interface / Terminal Block

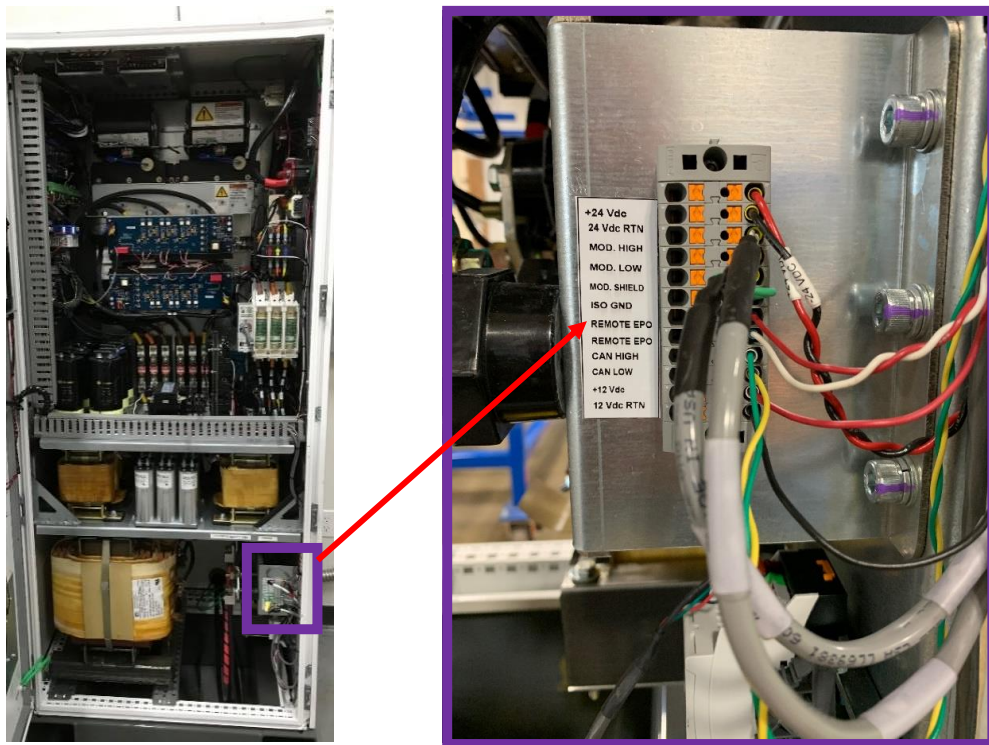

## 10. PCS OPERATION

### SAFETY CHECKS / PREPARING THE PCS FOR OPERATION

Performing a routine safety check each time before starting the PCS Equipment will minimize both the risk of injury to the operator and potential damage to the PCS Equipment or device under test. Before operating the PCS Equipment, check for obvious signs of damage. **The Commissioning Checklist must be filled out and approved by Rhombus prior to powering up the system.**

The following is a list of suggested items to be checked before operating the PCS Equipment:

- Inspect the equipment for visible signs of damage.
- Verify that all inlet and outlet vents are clear of debris. See for the air flow path.
- Inspect externally connected wires and cables for signs of damage, such as fraying or cracked insulation.
- Inspect internal cable and harness connections to ensure they did not come loose during shipping.
- **NOTE:** *Additional safety checks may be necessary depending on the installation of the RES Equipment. The safety checklist above is not intended to be all-inclusive.*

To power-up the PCS Equipment after proper installation follow these procedures:

**NOTE: DO NOT CONNECT BATTERY UNTIL INSTRUCTED TO BY RHOMBUS PERSONNEL. Make sure the battery connections are capped and away from any grounding source.**

1. Ensure that all electrical connections are clean, torqued, and free of wire strands and metal shavings.
2. Turn the external circuit breaker on and verify that the PCS is receiving 480VAC phase to ground and 277VAC phase to phase, +/- 10%. Voltages must be verified by a qualified electrician.
3. Turn the PCS ON/OFF Switch located on the inside of the door next to the battery to the ON position (either side of "ON" is acceptable).

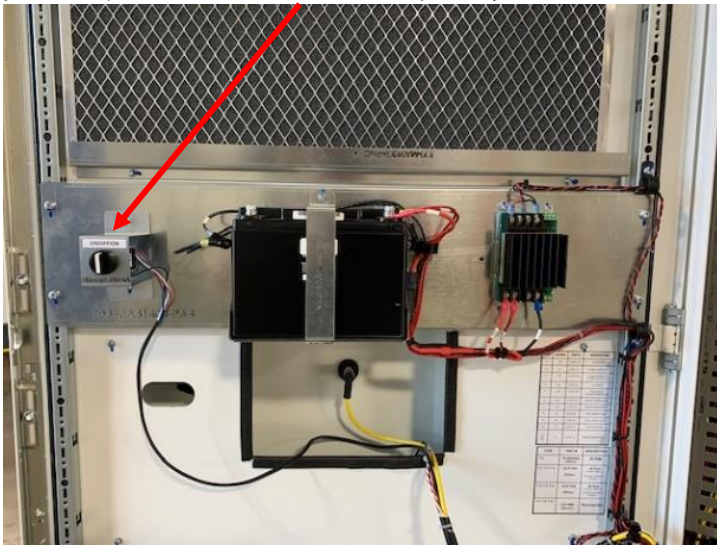

4. Close and lock the PCS door.
5. Turn AC Disconnect handle to ON position.
6. A green LED signals the PCS initial power up sequence is OK. The PCS is now ready for operation.

## PCS STATUS LED

One multi-color status LED is mounted on the front door enclosure panel.

LED Color	Status	Description
Green	ON	PCS is in active power delivery or IDLE mode
Yellow	WARNING (solid)	Maintenance / Test mode.
	WARNING (flashing)	Warnings are present in the system
Red	SHUTDOWN (solid)	Shutdown due to an internal fault, or ground fault

- If the LED is flashing Yellow, the system has detected a warning.
  - PCS Equipment will continue to run if the warning is not grid related.
- If it is a grid related warning (under/over voltage/frequency condition), the PCS power equipment will go to IDLE MODE and resume normal operation once the grid recovers.
  - The PCS Equipment automatically reconnects after 5 minutes of grid recovery.
- If the LED is solid Yellow, then the PCS is operating in Maintenance/Test Mode.
- If the LED is solid Red, a fault occurred which could not be cleared, and the PCS Equipment has entered Shutdown Mode.
  - The fault conditions must be investigated, addressed, and cleared either by remote access or by cycling power of the RES Equipment.

## EMERGENCY STOP

The emergency stop switch (E-STOP) switch is wired to the PCS. When pressed, the switch will immediately cease power output from the PCS and disconnect the PCS from both DC and AC grid connections. The EPO switch is connected in series with a low voltage power circuit to a grid side output contactor. When pressed, the circuit is broken, which will not only de-energize the contactor isolating the system from the grid, but also disable the controller switching in a few microseconds (hardware shut-off).

## 11.MAINTENANCE

### SAFETY PRECAUTIONS FOR EQUIPMENT MAINTENANCE

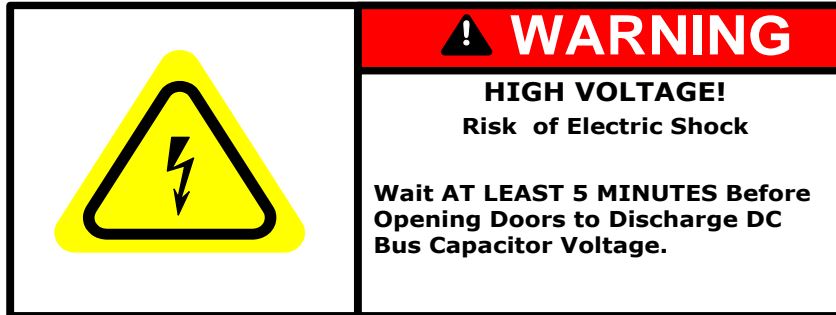

- Follow all LOTO protocols. Use caution before opening the doors or working on the equipment or transformer.
- Disconnect the DC from the vehicle and AC from the service panel before servicing the RES Equipment, since the DC input may supply hazardous voltage.
- The RES Equipment's DC-link capacitors will hold a charge for up to 5 minutes after the RES Equipment has been shut off, and the grid and DC input load or source have been disconnected from the RES Equipment. Wait 5 minutes before opening enclosure doors.
- Verify the presence of voltage with appropriately rated test instrumentation before working on the system. Check the voltage of the DC Link capacitors using a multi-meter and any area you are trying to work on.

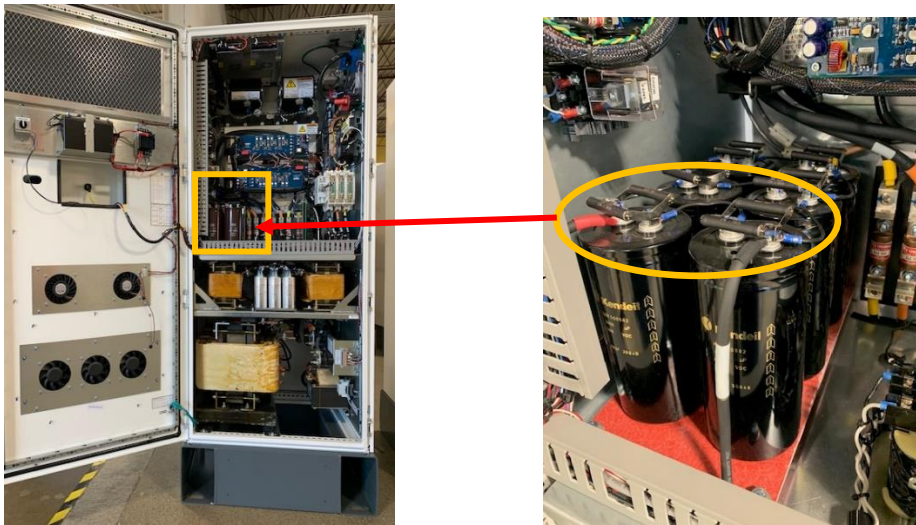

- Remove jewelry, watches, rings, and metal objects that can cause short circuits.
- Use anti-static wristbands when servicing electronic components.
- Be sure that all electrical connections and connectors are properly installed and connected with proper torque. Torque specifications for customer interface terminals can be found in this manual or equipment labels.
- For continued protection against risk of fire, only use replacement fuses of the same type and rating as the originally installed fuses.
- Avoid hazardous voltage situations that could result from unsafe conditions such as, but not limited to, the following:
  - Back-feed from the utility.

- Improper grounding.
- Handling electrical leads or devices with wet hands, or on wet ground.
- Frayed electrical leads.
- Working with or on an electrically hot system or component, or when connected to an energized load.
- Improper connection or re-connection of the terminal leads.
- Short circuits.
- Energized power sources including emergency power
- Possible battery bank connection to the DC bus.

## HIGH VOLTAGE ELECTRICAL EQUIPMENT MAINTENANCE

**NOTE: Failure to follow the maintenance guidelines may negatively affect the performance of the RES Equipment and may void the warranty.**

### HIGH POWER CABLE CONNECTIONS

**Due to normal thermal cycling, certain fasteners may loosen over time, resulting in increased impedance and possible heat damage. After an initial break-in period of ~30 days, all High Voltage cable connections should be re-torqued to the torque values specified on the PCS labels or document wiring table**

Additionally, these fasteners should be checked at 12-month intervals and re-torque as necessary.

Using the appropriate torque wrench, re-torque all fasteners listed in the **Wiring Specifications** tables in *Section 1.4 (Specifications)* to the torque value indicated in the tables. Be careful not to over-torque any connection, as damage to the fastener, wiring or terminal may occur.

### AIR INTAKE AND FILTERS

The air intake filters should be inspected and vacuumed every 3 to 6 months and replaced annually.

If the RES Equipment shutdowns due to high temperatures, check filter for excess accumulation of debris or contamination.



**CAUTION:** Do not spray water or use solvents to clean the enclosure vents. Excessive moisture within the enclosure can cause corrosion, damage circuitry, and increase the risk of fire.

### ENCLOSURE INLET AND EXHAUST VENTS

The enclosure vents clearance must be maintained and be kept clear of debris. If the RES Equipment shutdowns due to high temperature, check air intake and exhaust for signs of blockage.

#### RECOMMENDED MAINTENANCE INTERVAL SUMMARY

MAINTENANCE ITEM	INTERVAL
Re-Torque Field Installed Fasteners	After 30 days from initial start-up; every 12 months thereafter
Inspect Air Intake and Exhaust Vents	Periodically based on environment <ul style="list-style-type: none"> <li>● Inspection: every 3 months</li> <li>● Cleaning: every 12 months</li> </ul>

## LOCK OUT / TAG OUT

The inverter offers an option to lock the rotary door switch in the “OFF” position. This **does not** remove high voltage from all components inside the PCS enclosure but offers an additional power disconnect that may aid safe service of equipment connected to the DC output.

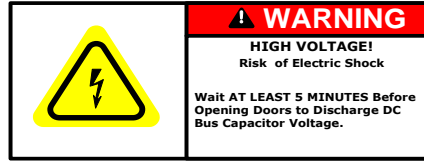

Shaft padlocking  
Cadenassage de l'axe  
Bloqueo con candado del eje

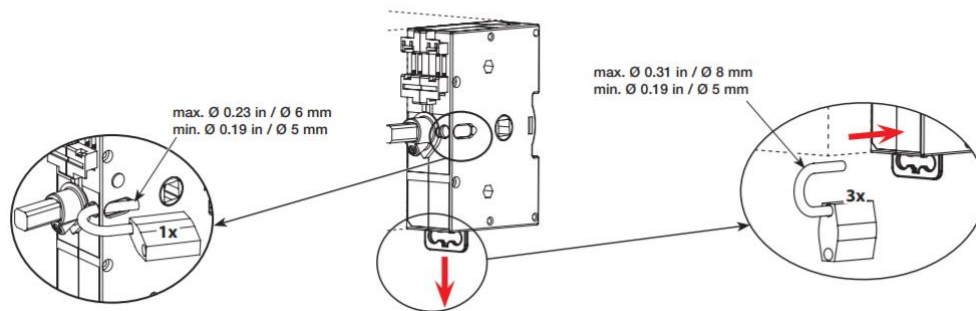

## RECOMMENDED SPARE PARTS LIST

(updated 02SEP21)

\*RSQ: Recommended stock quantity

PART NUMBER	Description	QTY	RISK	Lead Time
100-EAH0049-PAA	30KW GATE DRIVE CIRCUIT BOARD (GDB)	10	Low	In stock
100-EAH0052-PAC	60KW CUSTOMER INTERFACE CIRCUIT BOARD (CIU)	5	Avg.	In stock
100-EAH0054-PAA	INTERFACE TERMINAL CIRCUIT BOARD (ITB)	2	Avg.	In stock
100-EAH1365-PAA	60KW MAIN CONTROL CIRCUIT BOARD (MIU)	5	Avg.	In stock
100-EAH0050-PAC	60KW & 125kW VOLTAGE SENSE BOARD (VSB)	5	Avg.	4-5 weeks
100-EAV3375-PAA	60kW Voltage Sense Board (VSB) J5 cable (Used on new VSB board 0050-PAC)	5	Avg.	In stock
100-EAJ1141-PAA	Buss bar, DC interface	4	Low	In stock
100-EAM0023-PAA	Contactora, TE Connectivity 3-phase 200A	4	High	24 weeks
100-EAL0143-PAA	Fuse, 125A, Class T bolted	2	Maint.	In stock
100-EAL0352-PAA	FUSE,250A,DC INPUT POSITIVE	2	Maint.	In stock
100-EAL0456-PAA	Fuse, 100A, 600V Cube Fuse	2	Maint.	In stock
100-EAL1540-PAA	Fuse, 6A, Glass Cartridge	10	Maint.	In stock
100-EAL0611-PAA	Fuse, 1A, 600VAC/300VDC, CC, Time Delay	10	Maint.	In stock
100-EAL1714-PAA	FUSE,100A, Bolted	2	Maint.	In stock
100-EAM0030-PAA	CONTROL RELAY,ICE CUBE,PCS	4	Low	In stock
100-EAM0769-PAA	Contactora, 350A	5	High	In stock
100-EAN3059-PAA	Switch, 60kW AC Disconnect	1	Low	In stock
100-EAO2962-PAA	AC to DC POWER SUPPLY, 15V	2	Low	4-5 weeks
100-EAO2961-PAA	AC to DC POWER SUPPLY, 12V	2	Low	In stock
100-EAO1218-PAA	049561 "Power Supply, 12V TO 24V DC-DC"	2	Low	In stock
100-EAO1218-PAA	Power Supply, 24V, 50W	2	Low	In stock
100-EAS1674-PAA	Converter RS232 to RS485 CommFront	2	Low	In stock
100-EBB1177-PAA	FAN, COOLING	5	High	In stock
100-EBO3300-PAA	Assembly, Surge Arrestor	3	Maint.	In stock
100-EWB1123-PAC	048054 60KW EMI Filter	5	High	In stock
100-MBA0925-PAA	Insulator, Bus, 2300V	5	Low	In stock





# 12.APPENDIX

## APPENDIX 1A: DETAILED SCHEMATIC RES-DCVC60KW-480

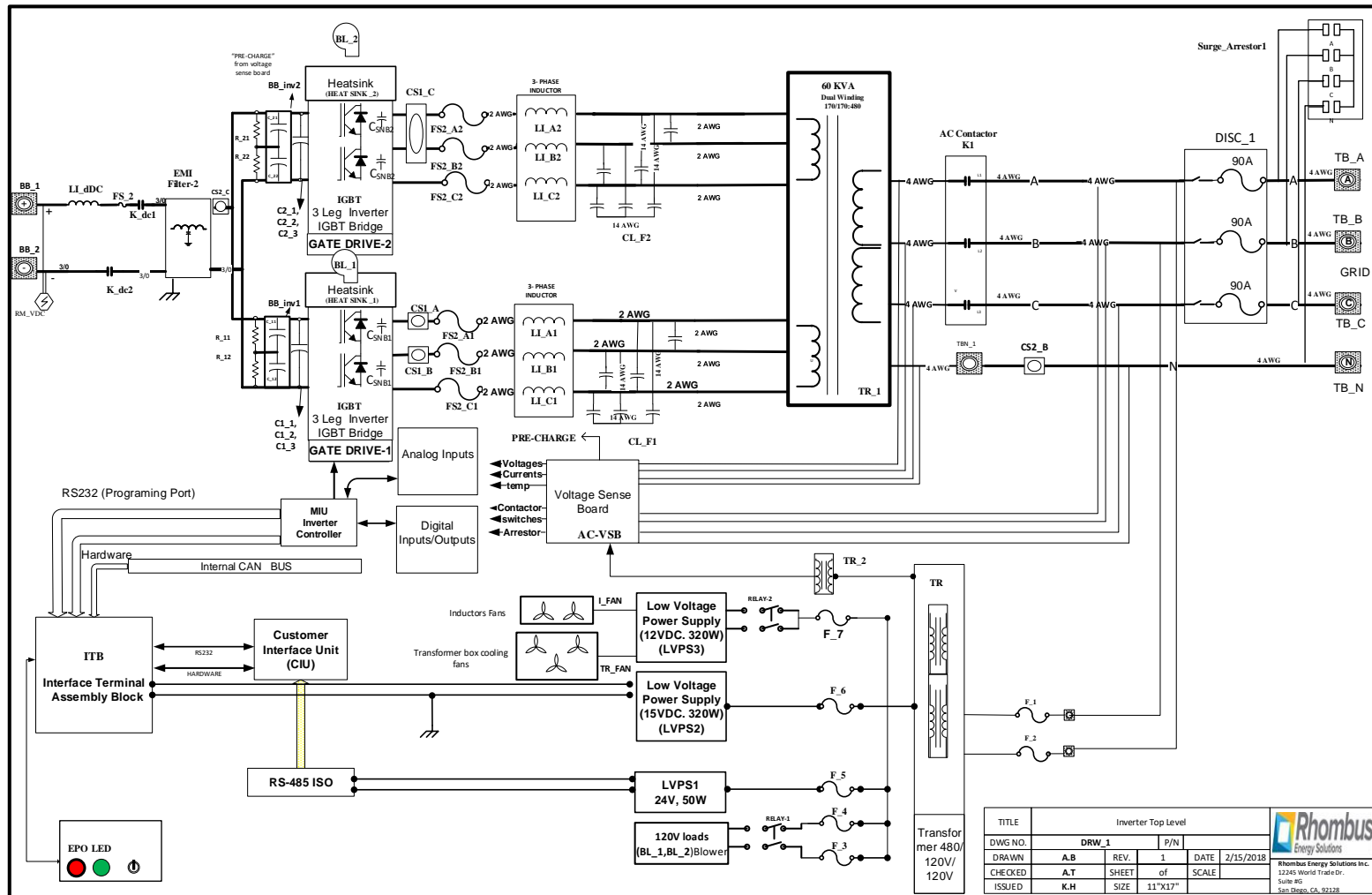

# APPENDIX 1B: DIMENSIONS (RES-DCVC60kW-480)

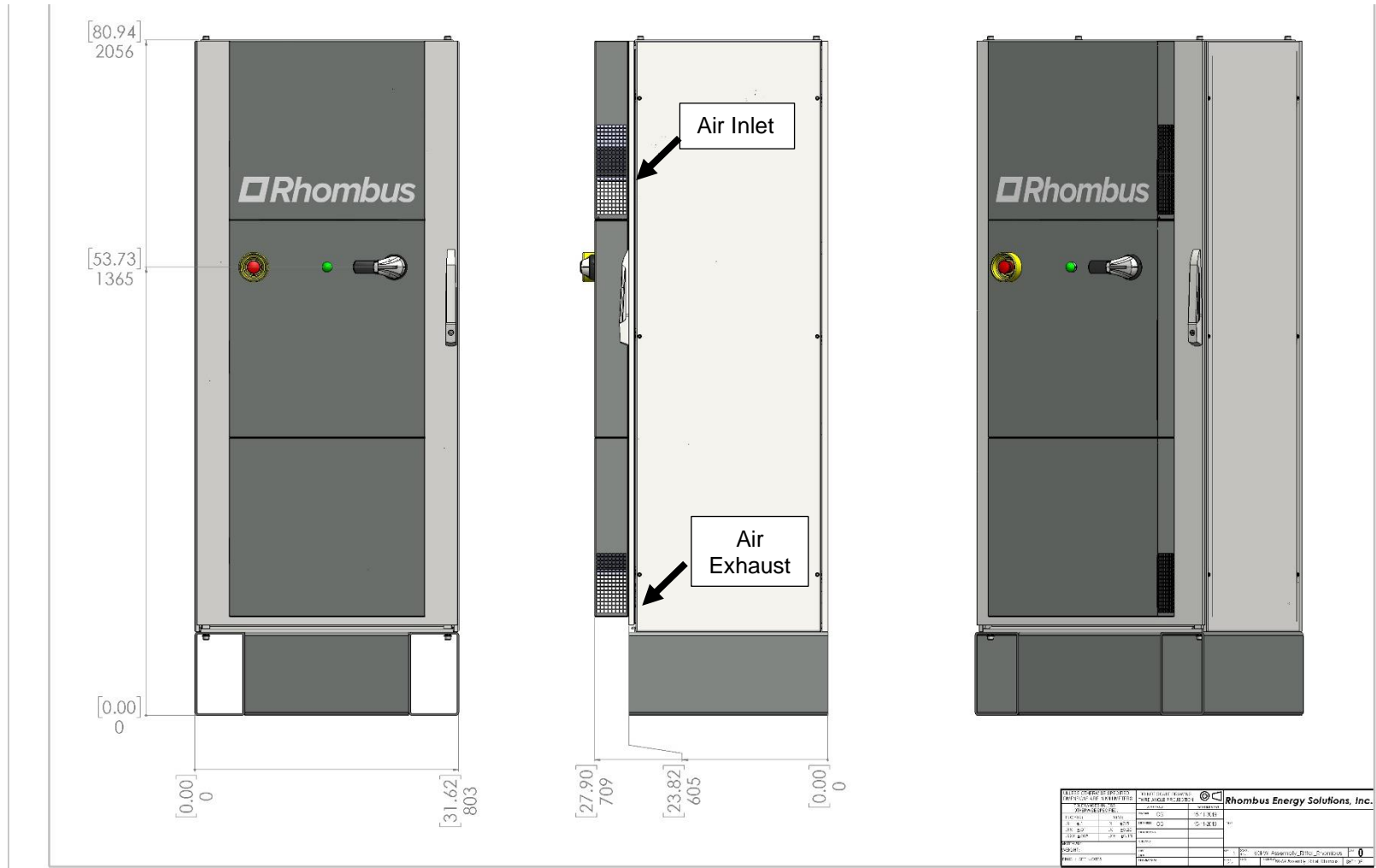

## APPENDIX 1C: INSTALLATION CLEARANCE REQUIREMENTS (RES-DCVC60KW-480)

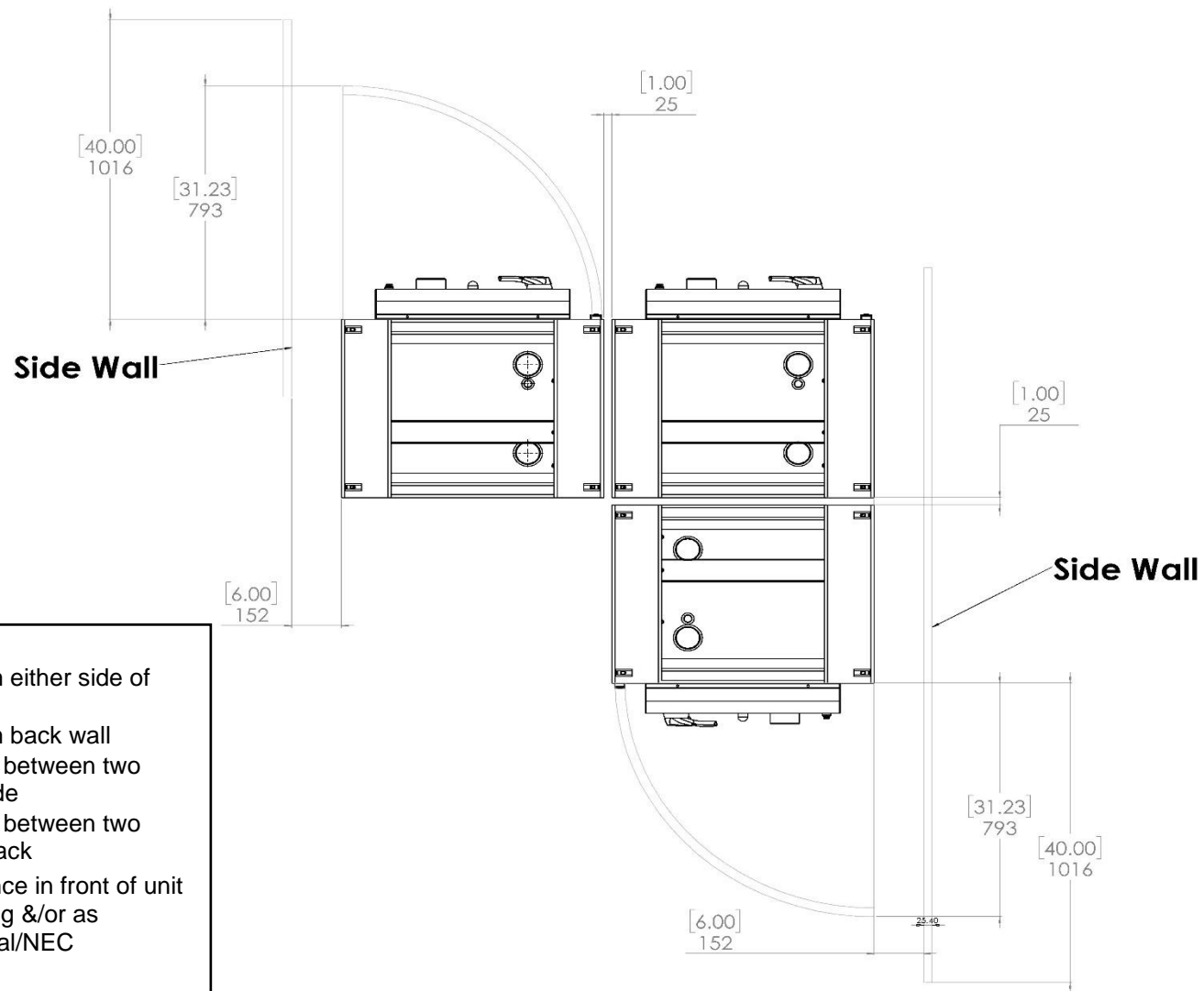

- Min 6 inch from either side of wall
- Min 1 inch from back wall
- Min 1-inch gap between two units side to side
- Min 1-inch gap between two units back to back
- 36-inch clearance in front of unit for door opening &/or as required by local/NEC requirements

APPENDIX 1D: ANCHOR AND CONDUIT INSTALLATION TEMPLATE (RES-DCVC60kW-480)

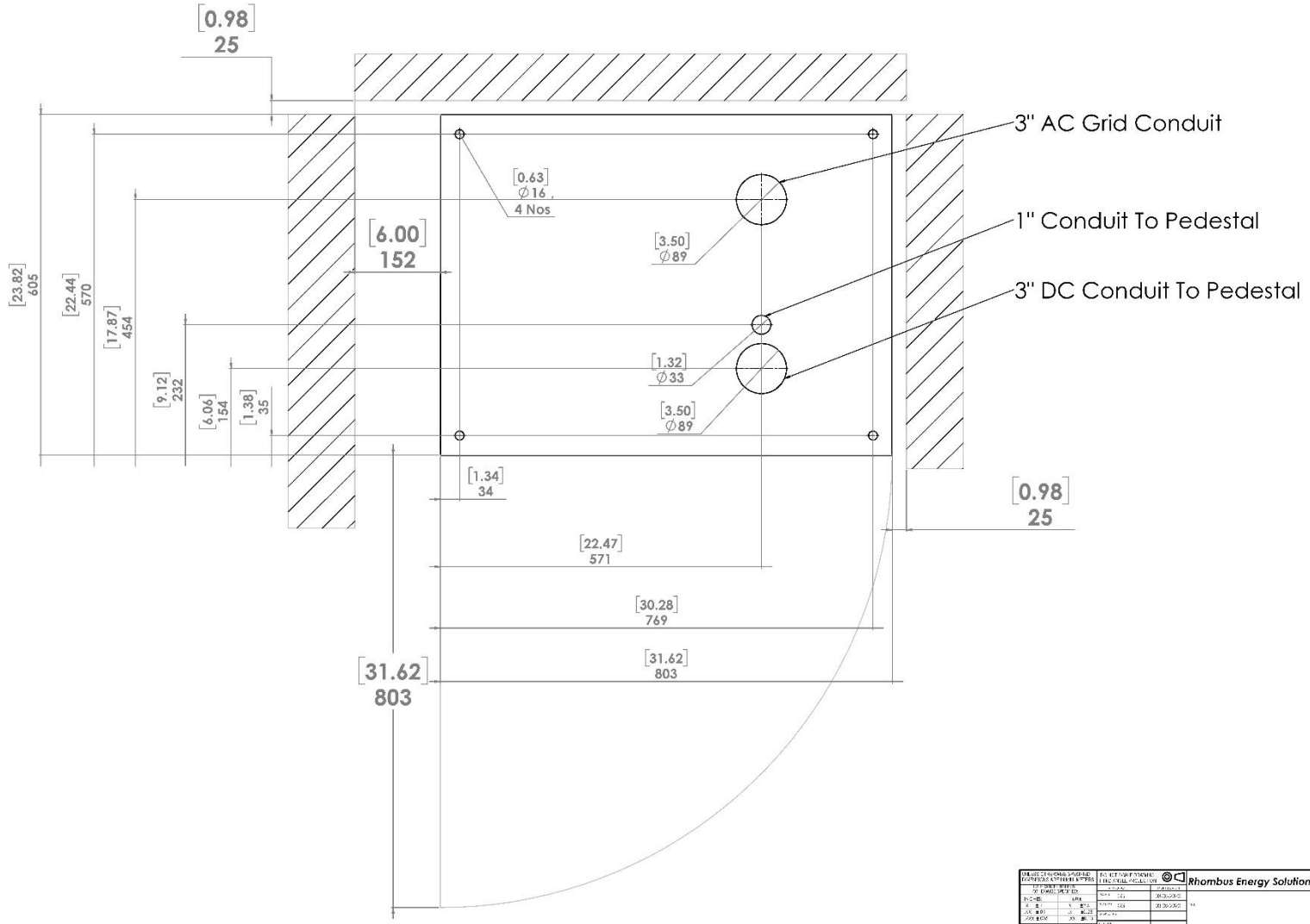

## APPENDIX 1E: ANCHOR AND CONDUIT INSTALLATION TEMPLATE (RES-DCVC60kW-480)

**Optional:** Conduit can be installed from the back of the PCS if coming up from the bottom is not available.

*Warning: Installer must evaluate installation location and any applicable codes and/or regulations related to allowable equipment installation and and/or minimum conduit or electrical connection height. (Eg: NFPA 70, NFPA.)*

